



COMBiLiFT

Customised Handling Solutions

COMBi[®]-WR4

Walkie Reach 4-Way

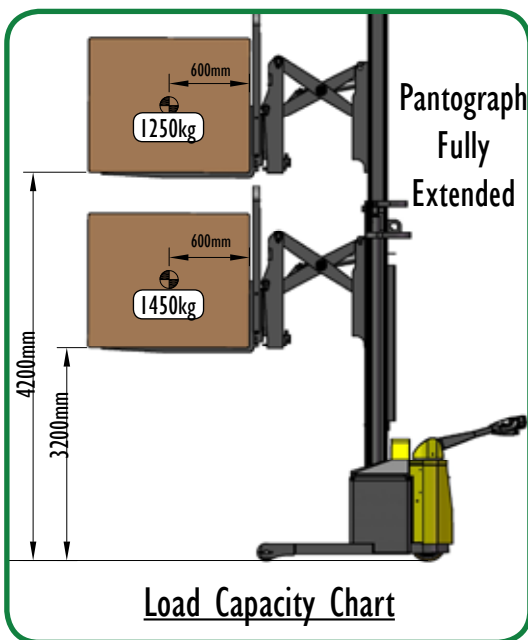

Multi Position Tiller- International Application No. PCT/EP2012/067238

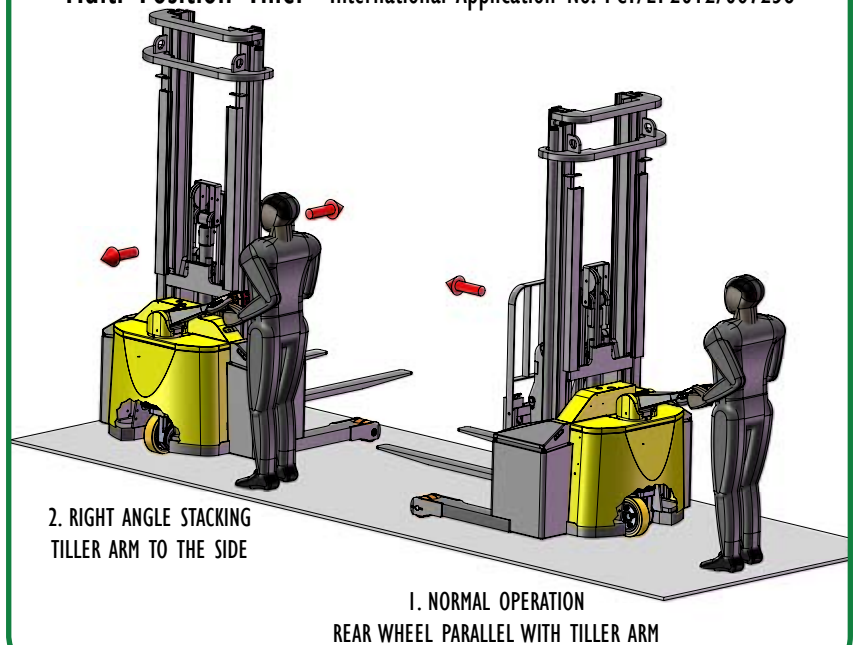



SPECIFICATIONS

COMBi[®]-WR4

International Application No. PCT/EP2012/067238
Multi Position Tiller.

Ref.	DESCRIPTION	STD
1a	Max. Lift Height	4200mm
1b	Free Lift Height	1500mm
2	Height Mast Closed	2700mm
3	Max. (Mast Raised)	5400mm
4	Overall Length	1950mm
5	Fork Travel	590mm
6	Ground Clearance Under Mast	80mm
7	Ground Clearance to Centre of Wheelbase	50mm
8	Width	1512mm
9	Outside Spread of Fork Arms	815mm
10	Track Front	1292mm
11	Frame Opening	1008mm
12	Load Centre Distance	600mm
13	Overhang Front	655mm
14	Wheelbase	1120mm
15	Overhang Back	175mm
16	Fork Side Shift	80mm Left / 80mm Right
17	Length from Face of Fork	880mm
18	Fork Backward Tilt	3°
19	Fork Forward Tilt	3°
20	Minimum Outside Radius	1350mm
21	Leg Height	282mm
22	Leg Length	530mm
A	Capacity	1450kg @ 3200mm Lift
B	Unladen Weight	2800kg
C	Maximum Ground Speed	6 Km/h
D	Gradability	5%
E	Battery Capacity	24V / 270 Ah
F	Fork Section	35mm x 100mm x 1070mm
G	Front Tyre x 4 (Polyurethane)	OD 200mm / Width 50mm
H	Rear Tyre (Vulkollan)	OD 250mm / Width 75mm
I	Standard Colour	Yellow & Grey
J	AC Electric Traction Motor	24V / 2.5 kW
K	AC Electric Pump Motor	24V / 5 kW

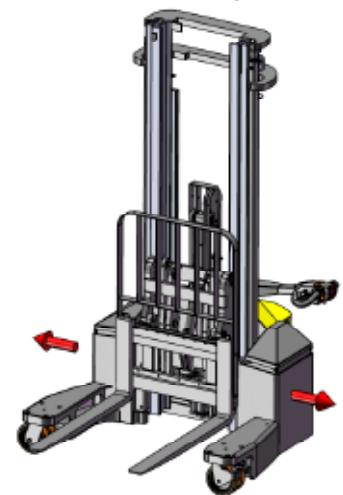
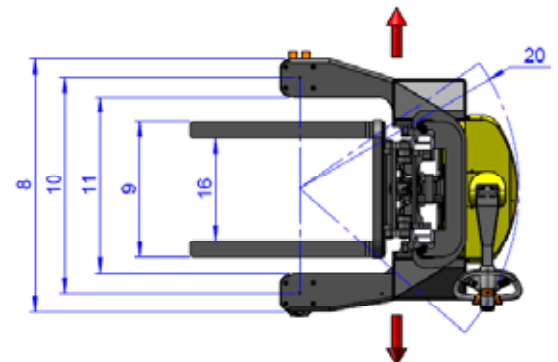
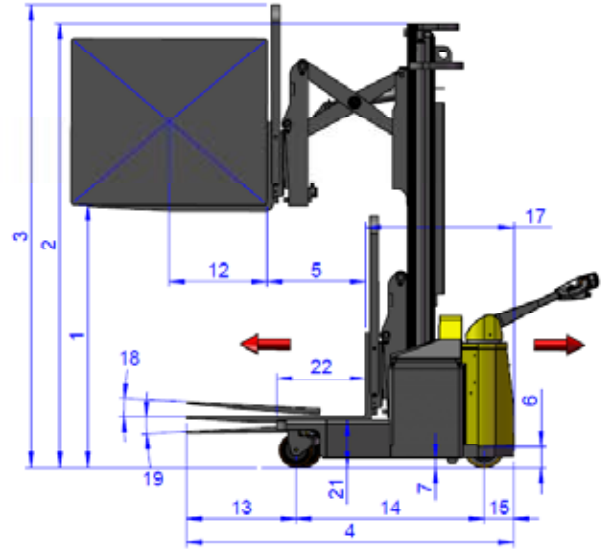

Features Include:

- Pantograph
- Power Steering
- AC Motor Technology
- 1200mm High Load Back Rest
- Rear Wheel Drive
- 80/80mm Side Shift

Distributed by:

COMBiLiFT

Co. Monaghan
Ireland

T: +353 47 80500

F: +353 47 80501

E: info@combilift.com

www.COMBiLiFT.com